

Varenummer: 0108057
 Beskrivelse: Seeger låsering JK 40 DIN 984

Mål

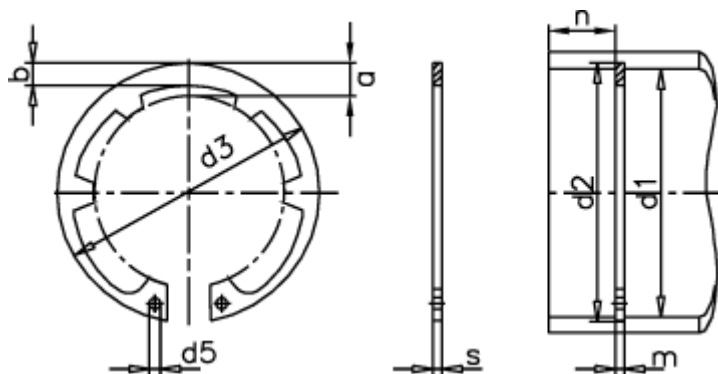

a max	= 7.2	d5 min	= 2.5	s	= 1.75
AN mm ²	= 162.0	FN kN	= 27.0	t	= 1.25
Antal takker	= 6	FRg kN	= 8.3	Tang	= ZGJ-3
b	= 4.0	FR kN	= 44.6	tol	= -0.06
Betegnelse	= JK 40	g	= 2.0	tol	= +0,90-0,39
d1	= 40	K kN-mm	= 80.1	tol	= +0,25
d2	= 42.5	m min	= 1.85	vægt kg/1000	= 5.30
d3	= 43.5	Nominal træk	= 3.8		